

Kompatibilnost sa sistemom ugradnje u zid prema međunarodnim standardima obezbeđena je uvođenjem prirubnice koja nosi 1 ili 2 modula. Ova prirubnica se postavlja u standardnu montažnu kutiju Ø60 mm uobičajeno uz pomoć stegača ili vijaka. Time je omogućeno da se program ALING MODE može ugrađivati kod adaptacije postojećih instalacija bez ugradnje novih montažnih kutija.

The compatibility with wall-mounted system according to the international standards is assured by introducing the flange carrying 1 or 2 modules. This flange is positioned into the standard installation box Ø60mm by using the clamps or screws. Such procedure allows ALING MODE programme to be installed when the existing installations are adapted, without inserting the new installation boxes.

Za sklopove za ugradnju 3 ili više modula obezbeđene su posebne montažne kutije na koje se prirubnica montira vijcima isporučenim zajedno sa prirubnicom.

The special installation boxes are provided for the installation of 3 or more module assemblies, onto which the flange is mounted by screws supplied with the flange.

U zavisnosti od načina ugradnje kutije se izrađuju za pune zidove:

Depending on the manner of installation the boxes are made for solid walls:

Ili za šuplje zidove (gipsane ploče, drvene ploče i slično).  
Or for hollow walls (gypsum boards, wooden boards and similar).

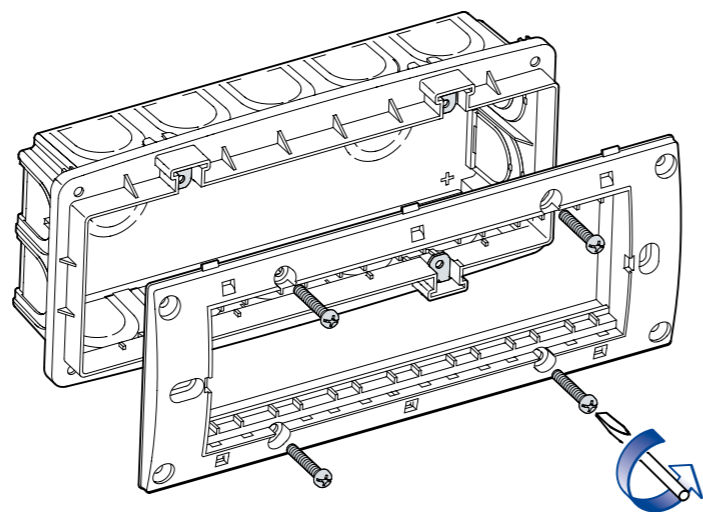
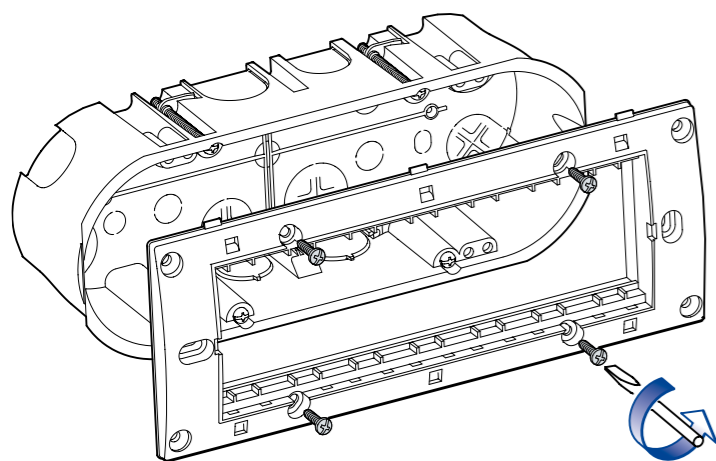

Postavljanje modula u noseću prirubnicu je veoma jednostavno ručnim utiskivanjem. Sklop modula i noseće prirubnice izveden je tako da je skidanje svih modula moguće sa prednje strane bez skidanja prirubnice sa montažne kutije. Dovoljno je skinuti taster ili blok priključnice i izvijačem otkaçiti modul. Kod pojedinih proizvoda (regulatori, VF priključnice) skidanje modula se može obaviti bez uklanjanja bloka.

Positioning of module into the holding flange is very simple by hand pressing. The module and holding flange assembly is made in such a way that it is possible to remove all modules from the front side without removing the flange from the installation box. It is sufficient to remove the button or the block of the socket outlet and to unhook the module by screw driver. In some products (dimmers, VF sockets) the removal of module can be done without block removal.

**Sklopka jednopolna 10AX/250V~**

- Usaglašeno sa IEC 60669-1,  
- Ugradnja u noseću prirubnicu utiskivanjem

- art. **655.0** beli taster
- art. **655.A** antracit taster
- art. **PP655.0** beli taster - zbirno pakovanje 10 kom
- art. **PP655.A** antracit taster - zbirno pakovanje 10 kom

**Single-pole switch 10AX/250V~**

- Complied with IEC 60669-1  
- Installation into the holding flange by pressing

- art. **655.0** white button
- art. **655.A** anthracite button
- art. **PP655.0** white button - collective packing 10 pcs.
- art. **PP655.A** anthracite button - collective packing 10 pcs.

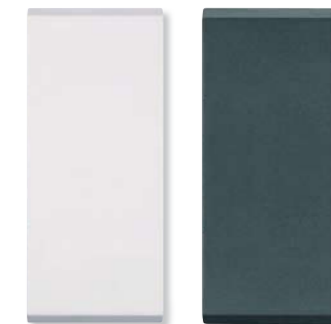

**Sklopka naizmenična 10AX/250V~**

- Usaglašeno sa IEC 60669-1,  
- Ugradnja u noseću prirubnicu utiskivanjem

- art. **657.0** beli taster
- art. **657.A** antracit taster
- art. **PP657.0** beli taster - zbirno pakovanje 10 kom
- art. **PP657.A** antracit taster - zbirno pakovanje 10 kom

**Alternative switch 10AX/250V~**

- Complied with IEC 60669-1  
- Installation into the holding flange by pressing

- art. **657.0** white button
- art. **657.A** anthracite button
- art. **PP657.0** white button - collective packing 10 pcs.
- art. **PP657.A** anthracite button - collective packing 10 pcs.

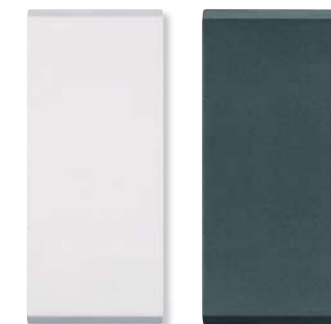

**Sklopka ukrasna 2M 10AX/250V~**

- Usaglašeno sa IEC 60669-1,  
- Ugradnja u noseću prirubnicu utiskivanjem

- art. **658.0** beli taster
- art. **658.A** antracit taster
- art. **PP658.0** beli taster - zbirno pakovanje 5 kom
- art. **PP658.A** antracit taster - zbirno pakovanje 5 kom

**Cross-switch 2M 10AX/250V~**

- Complied with IEC 60669-1  
- Installation into the holding flange by pressing

- art. **658.0** white button
- art. **658.A** anthracite button
- art. **PP658.0** white button - collective packing 5 pcs.
- art. **PP658.A** anthracite button - collective packing 5 pcs.



**Sklopka dvopolna 2M 10AX/250V~**

- Usaglašeno sa IEC 60669-1,  
- Ugradnja u noseću prirubnicu utiskivanjem

- art. **6554.0** beli taster
- art. **6554.A** antracit taster
- art. **PP6554.0** beli taster - zbirno pakovanje 5 kom
- art. **PP6554.A** antracit taster - zbirno pakovanje 5 kom

**Double-pole switch 2M 10AX/250V~**

- Complied with IEC 60669-1,  
- Installation into the holding flange by pressing

- art. **6554.0** white button
- art. **6554.A** anthracite button
- art. **PP6554.0** white button - collective packing 5 pcs
- art. **PP6554.A** anthracite button - collective packing 5 pcs



**Sklopka jednopolna 2M  
10AX/250V~**

- Usaglašeno sa IEC 60669-1,
- Ugradnja u noseću prirubnicu utiskivanjem

art. **6552.0** beli taster  
 art. **6552.A** antracit taster  
 art. **PP6552.0** beli taster - zbirno pakovanje 5 kom  
 art. **PP6552.A** antracit taster - zbirno pakovanje 5 kom

**Single-pole switch 2M  
10AX/250V~**

- Complied with IEC 60669-1,
- Installation into the holding flange by pressing

art. **6552.0** white button  
 art. **6552.A** anthracite button  
 art. **PP6552.0** white button - collective packing 5 pcs  
 art. **PP6552.A** anthracite button - collective packing 5 pcs



**Taster sklopka za svetlo  
10AX/250V~**

- Usaglašeno sa IEC 60669-1,
- Ugradnja u noseću prirubnicu utiskivanjem

art. **659.0** beli taster  
 art. **659.A** antracit taster  
 art. **PP659.0** beli taster  
 zbirno pakovanje 10 kom  
 art. **PP659.A** antracit taster  
 zbirno pakovanje 10 kom

**Light push-button switch  
10AX/250V~**

- Complied with IEC 60669-1
- Installation into the holding flange by pressing

art. **659.0** white button  
 art. **659.A** anthracite button  
 art. **PP659.0** white button  
 collective packing 10 pcs.  
 art. **PP659.A** anthracite button  
 collective packing 10 pcs.



**Sklopka naizmenična 2M  
10AX/250V~**

- Usaglašeno sa IEC 60669-1,
- Ugradnja u noseću prirubnicu utiskivanjem

art. **6572.0** beli taster  
 art. **6572.A** antracit taster  
 art. **PP6572.0** beli taster - zbirno pakovanje 5 kom  
 art. **PP6572.A** antracit taster - zbirno pakovanje 5 kom

**Alternative switch 2M  
10AX/250V~**

- Complied with IEC 60669-1
- Installation into the holding flange by pressing

art. **6572.0** white button  
 art. **6572.A** anthracite button  
 art. **PP6572.0** white button - collective packing 5 pcs  
 art. **PP6572.A** anthracite button - collective packing 5 pcs



**Taster sklopka za svetlo 2M  
10AX/250V~**

- Usaglašeno sa IEC 60669-1,
- Ugradnja u noseću prirubnicu utiskivanjem

art. **6590.0** beli taster  
 art. **6590.A** antracit taster  
 art. **PP6590.0** beli taster  
 zbirno pakovanje 5 kom  
 art. **PP6590.A** antracit taster  
 zbirno pakovanje 5 kom

**Light push-button switch 2M  
10AX/250V~**

- Complied with IEC 60669-1
- Installation into the holding flange by pressing

art. **6590.0** white button  
 art. **6590.A** anthracite button  
 art. **PP6590.0** white button  
 collective packing 5 pcs.  
 art. **PP6590.A** anthracite button  
 collective packing 5 pcs.



**Sklopka jednopolna  
sa indicijom 10AX/250V~**

- Usaglašeno sa IEC 60669-1,
  - Ugradnja u noseću prirubnicu utiskivanjem,
  - *Indikacija svetli kada je sklopka isključena:*
- art. **675.0** beli taster  
 art. **675.A** antracit taster  
 art. **PP675.0** beli taster - zbirno pakovanje 10 kom  
 art. **PP675.A** antracit taster - zbirno pakovanje 10 kom
- *Indikacija svetli kada je sklopka uključena:*
- art. **6752.0** beli taster  
 art. **6752.A** antracit taster  
 art. **PP6752.0** beli taster - zbirno pakovanje 10 kom  
 art. **PP6752.A** antracit taster - zbirno pakovanje 10 kom

**Single-pole switch  
with indication 10AX/250V~**

- Complied with IEC 60669-1
  - Installation into the holding flange by pressing
  - *Indication turns on when the switch is off:*
- art. **675.0** white button  
 art. **675.A** anthracite button  
 art. **PP675.0** white button - collective packing 10 pcs.  
 art. **PP675.A** anthracite button - collective packing 10 pcs.
- *Indication turns on when the switch is on:*
- art. **6752.0** white button  
 art. **6752.A** anthracite button  
 art. **PP6752.0** white button - collective packing 10 pcs.  
 art. **PP6752.A** anthracite button - collective packing 10 pcs.



**Taster sklopka za svetlo  
sa indicijom 10AX/250V~**

- Usaglašeno sa IEC 60669-1,
- Ugradnja u noseću prirubnicu utiskivanjem,
- *Indikacija svetli kada je sklopka isključena*

art. **6591.0** beli taster  
 art. **6591.A** antracit taster  
 art. **PP6591.0** beli taster  
 zbirno pakovanje 10 kom  
 art. **PP6591.A** antracit taster  
 zbirno pakovanje 10 kom

**Light push-button switch  
with indication 10AX/250V~**

- Complied with IEC 60669-1
- Installation into the holding flange by pressing
- *Indication turns on when the switch is off*

art. **6591.0** white button  
 art. **6591.A** anthracite button  
 art. **PP6591.0** white button  
 collective packing 10 pcs.  
 art. **PP6591.A** anthracite button  
 collective packing 10 pcs.



**Sklopka naizmenična  
sa indicijom 10AX/250V~**

- Usaglašeno sa IEC 60669-1,
- Ugradnja u noseću prirubnicu utiskivanjem,
- *Indikacija svetli kada je strujno kolo otvoreno*

art. **677.0** beli taster  
 art. **677.A** antracit taster  
 art. **PP677.0** beli taster - zbirno pakovanje 10 kom  
 art. **PP677.A** antracit taster - zbirno pakovanje 10 kom

**Alternative switch  
with indication 10AX/250V~**

- Complied with IEC 60669-1
- Installation into the holding flange by pressing
- *Indication turns on when the circuit is open*

art. **677.0** white button  
 art. **677.A** anthracite button  
 art. **PP677.0** white button - collective packing 10 pcs.  
 art. **PP677.A** anthracite button - collective packing 10 pcs.



**Taster sklopka za svetlo 2M  
sa indicijom 10AX/250V~**

- Usaglašeno sa IEC 60669-1,
- Ugradnja u noseću prirubnicu utiskivanjem,
- *Indikacija svetli kada je sklopka isključena*

art. **65901.0** beli taster  
 art. **65901.A** antracit taster  
 art. **PP65901.0** beli taster  
 zbirno pakovanje 5 kom  
 art. **PP65901.A** antracit taster  
 zbirno pakovanje 5 kom

**Light push-button switch 2M  
with indication 10AX/250V~**

- Complied with IEC 60669-1
- Installation into the holding flange by pressing
- *Indication turns on when the switch is off*

art. **65901.0** white button  
 art. **65901.A** anthracite button  
 art. **PP65901.0** white button  
 collective packing 5 pcs.  
 art. **PP65901.A** anthracite button  
 collective packing 5 pcs.





**Taster sklopka za zvono  
10AX/250V~**

- Usaglašeno sa IEC 60669-1,
- Ugradnja u noseću prirubnicu utiskivanjem

art. **660.0** beli taster  
 art. **660.A** antracit taster  
 art. **PP660.0** beli taster  
 zbirno pakovanje 10 kom  
 art. **PP660.A** antracit taster  
 zbirno pakovanje 10 kom

**Door bell push-button switch  
10AX/250V~**

- Complied with IEC 60669-1
- Installation into the holding flange by pressing

art. **660.0** white button  
 art. **660.A** anthracite button  
 art. **PP660.0** white button  
 collective packing 10 pcs.  
 art. **PP660.A** anthracite button  
 collective packing 10 pcs.

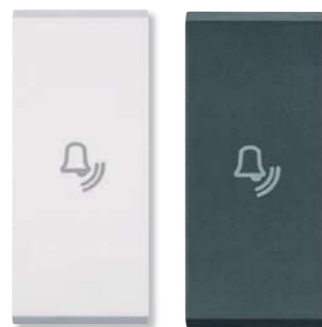

**Sklopka ukrсна 2M  
sa indicijom 10AX/250V~**

- Usaglašeno sa IEC 60669-1,
- Ugradnja u noseću prirubnicu utiskivanjem,
- Indikacija svetli kada je strujno kolo otvoreno

art. **678.0** beli taster  
 art. **678.A** antracit taster  
 art. **PP678.0** beli taster - zbirno pakovanje 5 kom  
 art. **PP678.A** antracit taster - zbirno pakovanje 5 kom

**Cross-switch 2M  
with indication 10AX/250V~**

- Complied with IEC 60669-1
- Installation into the holding flange by pressing
- Indication turns on when the circuit is open

art. **678.0** white button  
 art. **678.A** anthracite button  
 art. **PP678.0** white button - collective packing 5 pcs.  
 art. **PP678.A** anthracite button - collective packing 5 pcs.



**Taster sklopka za zvono 2M  
10AX/250V~**

- Usaglašeno sa IEC 60669-1,
- Ugradnja u noseću prirubnicu utiskivanjem

art. **6600.0** beli taster  
 art. **6600.A** antracit taster  
 art. **PP6600.0** beli taster  
 zbirno pakovanje 5 kom  
 art. **PP6600.A** antracit taster  
 zbirno pakovanje 5 kom

**Door bell push-button switch 2M  
10AX/250V~**

- Complied with IEC 60669-1
- Installation into the holding flange by pressing

art. **6600.0** white button  
 art. **6600.A** anthracite button  
 art. **PP6600.0** white button  
 collective packing 5 pcs.  
 art. **PP6600.A** anthracite button  
 collective packing 5 pcs.



**Taster sklopka jednopolna  
10AX/250V~**

- Usaglašeno sa IEC 60669-1,
- Ugradnja u noseću prirubnicu utiskivanjem

art. **689.0** beli taster  
 art. **689.A** antracit taster  
 art. **PP689.0** beli taster - zbirno pakovanje 10 kom  
 art. **PP689.A** antracit taster - zbirno pakovanje 10 kom

**Single-pole push-button  
switch 10AX/250V~**

- Complied with IEC 60669-1
- Installation into the holding flange by pressing

art. **689.0** white button  
 art. **689.A** anthracite button  
 art. **PP689.0** white button - collective packing 10 pcs.  
 art. **PP689.A** anthracite button - collective packing 10 pcs.



**Taster sklopka za zvono  
sa indicijom 10AX/250V~**

- Usaglašeno sa IEC 60669-1,
- Ugradnja u noseću prirubnicu utiskivanjem,
- Indikacija svetli kada je sklopka isključena

art. **6601.0** beli taster  
 art. **6601.A** antracit taster  
 art. **PP6601.0** beli taster  
 zbirno pakovanje 10 kom  
 art. **PP6601.A** antracit taster  
 zbirno pakovanje 10 kom

**Door bell push-button switch 2M  
with indication 10AX/250V~**

- Complied with IEC 60669-1
- Installation into the holding flange by pressing
- Indication turns on when the switch is off

art. **6601.0** white button  
 art. **6601.A** anthracite button  
 art. **PP6601.0** white button  
 collective packing 10 pcs.  
 art. **PP6601.A** anthracite button  
 collective packing 10 pcs.



**Taster sklopke  
za roletne 2M  
10AX/250V~**

- Usaglašeno sa IEC 60669-1,
- Ugradnja u noseću prirubnicu utiskivanjem,
- Par taster sklopki povezanih za upravljanje kretanjem elektromotora za roletne u dva smera

art. **690.0** beli taster  
 art. **690.A** antracit taster  
 art. **PP690.0** beli taster  
 zbirno pakovanje 5 kom  
 art. **PP690.A** antracit taster  
 zbirno pakovanje 5 kom

**Push-button switches  
for rolling shutters 2M  
10AX/250V~**

- Complied with IEC 60669-1
- Installation into the holding flange by pressing
- A pair of connected push-button switches for the control of rolling shutters electric motor movement in two directions

art. **690.0** white button  
 art. **690.A** anthracite button  
 art. **PP690.0** white button  
 collective packing 5 pcs.  
 art. **PP690.A** anthracite button  
 collective packing 5 pcs.



**Taster sklopka za zvono 2M  
sa indicijom 10AX/250V~**

- Usaglašeno sa IEC 60669-1,
- Ugradnja u noseću prirubnicu utiskivanjem,
- Indikacija svetli kada je sklopka isključena

art. **66001.0** beli taster  
 art. **66001.A** antracit taster  
 art. **PP66001.0** beli taster  
 zbirno pakovanje 5 kom  
 art. **PP66001.A** antracit taster  
 zbirno pakovanje 5 kom

**Light push-button switch 2M  
with indication 10AX/250V~**

- Complied with IEC 60669-1
- Installation into the holding flange by pressing
- Indication turns on when the switch is off

art. **66001.0** white button  
 art. **66001.A** anthracite button  
 art. **PP66001.0** white button  
 collective packing 5 pcs.  
 art. **PP66001.A** anthracite button  
 collective packing 5 pcs.



➤ **Sklopka jednopolna bez tastera 10AX/250V~**

- Usaglašeno sa IEC 60669-1,
- Ugradnja u noseću pribudnicu utiskivanjem,

art. **6551**  
art. **PP6551** zbirno pakovanje 10 kom

**Single-pole switch without button 10AX/250V~**

- Complied with IEC 60669-1
- Installation into the holding flange by pressing

art. **6551**  
art. **PP6551** collective packing 10 pcs.



➤ **Sklopka naizmenična bez tastera 10AX/250V~**

- Usaglašeno sa IEC 60669-1,
- Ugradnja u noseću pribudnicu utiskivanjem,

art. **6571**  
art. **PP6571** zbirno pakovanje 10 kom

**Alternative switch without button 10AX/250V~**

- Complied with IEC 60669-1
- Installation into the holding flange by pressing

art. **6571**  
art. **PP6571** collective packing 10 pcs.



➤ **Sklopka jednopolna indikatorska bez tastera 10AX/250V~**

- Usaglašeno sa IEC 60669-1,
- Ugradnja u noseću pribudnicu utiskivanjem,
- Indikacija svetli kada je sklopka uključena

art. **6751**  
art. **PP6751** zbirno pakovanje 10 kom

**Single-pole switch with indication without button 10AX/250V~**

- Complied with IEC 60669-1
- Installation into the holding flange by pressing
- Indication turns on when the switch is on

art. **6751**  
art. **PP6751** collective packing 10 pcs.



➤ **Sklopka jednopolna bez tastera 16AX/250V~**

- Usaglašeno sa IEC 60669-1,
- Ugradnja u noseću pribudnicu utiskivanjem,

art. **6851**  
art. **PP6851** zbirno pakovanje 10 kom

**Single-pole switch without button 16AX/250V~**

- Complied with IEC 60669-1
- Installation into the holding flange by pressing

art. **6851**  
art. **PP6851** collective packing 10 pcs.



➤ **Sklopka naizmenična bez tastera 16AX/250V~**

- Usaglašeno sa IEC 60669-1,
- Ugradnja u noseću pribudnicu utiskivanjem,

art. **6871**  
art. **PP6871** zbirno pakovanje 10 kom

**Alternative switch without button 16AX/250V~**

- Complied with IEC 60669-1
- Installation into the holding flange by pressing

art. **6871**  
art. **PP6871** collective packing 10 pcs.



➤ **Sklopka jednopolna indikatorska bez tastera 16AX/250V~**

- Usaglašeno sa IEC 60669-1,
- Ugradnja u noseću pribudnicu utiskivanjem,
- Indikacija svetli kada je sklopka uključena

art. **6691**  
art. **PP6691** zbirno pakovanje 10 kom

**Single-pole switch with indication without button 16AX/250V~**

- Complied with IEC 60669-1
- Installation into the holding flange by pressing
- Indication turns on when the switch is on

art. **6691**  
art. **PP6691** collective packing 10 pcs.



Dupli tasteri se mogu postavljati na sklopke širine modula 22,2 mm uz korišćenje posebnog nosača koji se isporučuje uz taster. Nosač se u pribudnicu postavi pored sklopke, a taster na sklopku i nosač zajedno. Kod tastera sa indikacijom voditi računa o položaju sklopke i nosača tako da otvor za indikaciju dođe iznad tinjalice na sklopki.

Two-gang switch buttons can be placed on to the 22,2 mm width switches using specific holder supplied with button. Holder should be placed close to switch, and button on the switch and holder together. For buttons with indication it is necessary to place holder and switch properly in order to indicating hole were above the indicating katheron.

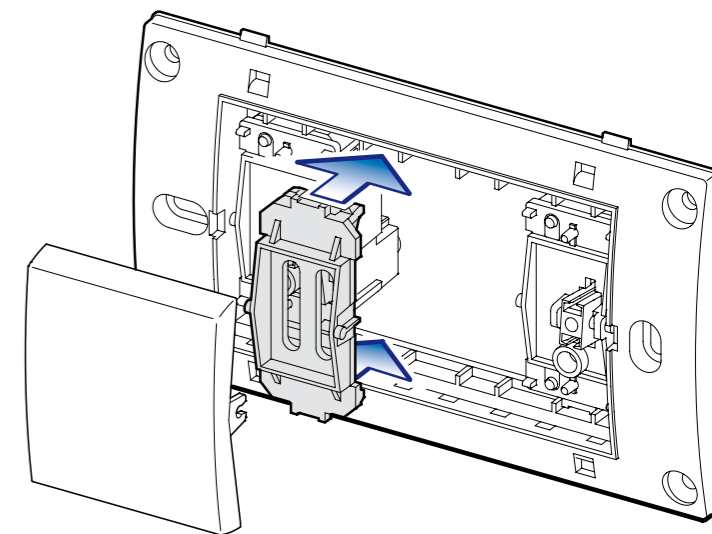

➤ **Sklopka jednopolna 16AX/250V~**

- Usaglašeno sa IEC 60669-1,
- Ugradnja u noseću pribudnicu utiskivanjem

art. **685.0** beli taster  
art. **685.A** antracit taster  
art. **PP685.0** beli taster - zbirno pakovanje 10 kom  
art. **PP685.A** antracit taster - zbirno pakovanje 10 kom

**Single-pole switch 16AX/250V~**

- Complied with IEC 60669-1
- Installation into the holding flange by pressing

art. **685.0** white button  
art. **685.A** anthracite button  
art. **PP685.0** white button - collective packing 10 pcs.  
art. **PP685.A** anthracite button - collective packing 10 pcs.

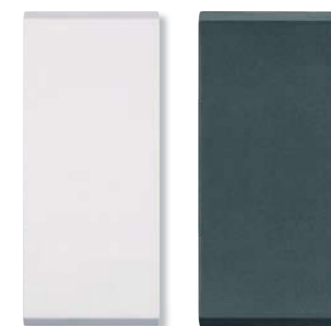

➤ **Sklopka naizmenična 16AX/250V~**

- Usaglašeno sa IEC 60669-1,
- Ugradnja u noseću pribudnicu utiskivanjem

art. **687.0** beli taster  
art. **687.A** antracit taster  
art. **PP687.0** beli taster - zbirno pakovanje 10 kom  
art. **PP687.A** antracit taster - zbirno pakovanje 10 kom

**Alternative switch 16AX/250V~**

- Complied with IEC 60669-1
- Installation into the holding flange by pressing

art. **687.0** white button  
art. **687.A** anthracite button  
art. **PP687.0** white button - collective packing 10 pcs.  
art. **PP687.A** anthracite button - collective packing 10 pcs.



➤ **Sklopka ukrсна 2M 16AX/250V~**

- Usaglašeno sa IEC 60669-1,
- Ugradnja u noseću pribudnicu utiskivanjem

art. **688.0** beli taster  
art. **688.A** antracit taster  
art. **PP688.0** beli taster - zbirno pakovanje 5 kom  
art. **PP688.A** antracit taster - zbirno pakovanje 5 kom

**Cross-switch 2M 16AX/250V~**

- Complied with IEC 60669-1
- Installation into the holding flange by pressing

art. **688.0** white button  
art. **688.A** anthracite button  
art. **PP688.0** white button - collective packing 5 pcs.  
art. **PP688.A** anthracite button - collective packing 5 pcs.

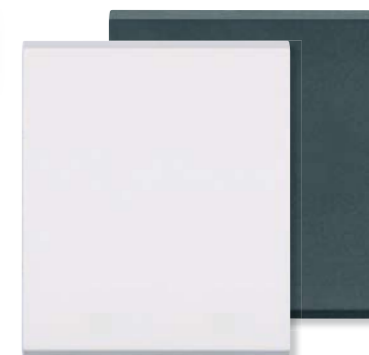



**Sklopka jednopolna sa indikacijom 16AX/250V~**

- Usaglašeno sa IEC 60669-1,
- Ugradnja u noseću prirubnicu utiskivanjem,
- Indikacija svetli kada je sklopka isključena

art. **669.0** beli taster  
 art. **669.A** antracit taster  
 art. **PP669.0** beli taster - zbirno pakovanje 10 kom  
 art. **PP669.A** antracit taster - zbirno pakovanje 10 kom

**Single-pole switch with indication 16AX/250V~**

- Complied with IEC 60669-1
- Installation into the holding flange by pressing
- Indication turns on when the switch is off

art. **669.0** white button  
 art. **669.A** anthracite button  
 art. **PP669.0** white button - collective packing 10 pcs.  
 art. **PP669.A** anthracite button - collective packing 10 pcs.



**Regulator jačine svetlosti 40-300VA, 230V~/50Hz**

- Za sijalice sa užarenim vlaknom i halogene sijalice sa standardnim transformatorom 230V~ 40-300W,
- Za halogene sijalice sa standardnim transformatorom 40-300VA,
- Usaglašeno sa IEC 60669-2-1,
- Ugradnja u noseću prirubnicu utiskivanjem,
- Indikacija

art. **667.0** beli  
 art. **667.A** antracit

**Dimmer 40-300VA, 230V~/50Hz**

- For the incadescent lamps and halogen lamps with standard transformer 230V~ 40-300W,
- For halogen lamps with standard transformer 40-300VA,
- Complied with IEC 60669-2-1
- Installation into the holding flange by pressing
- Indication

atr. **667.0** white  
 art. **667.A** anthracite



**Sklopka jednopolna indikatorska 16AX/250V~**

- Usaglašeno sa IEC 60669-1,
- Ugradnja u noseću prirubnicu utiskivanjem,
- Indikacija svetli kada je sklopka uključena

art. **6692.0** beli taster  
 art. **6692.A** antracit taster  
 art. **PP6692.0** beli taster - zbirno pakovanje 10 kom  
 art. **PP6692.A** antracit taster - zbirno pakovanje 10 kom

**Single-pole switch with indication 16AX/250V~**

- Complied with IEC 60669-1
- Installation into the holding flange by pressing
- Indication turns on when the switch is on

art. **6692.0** white button  
 art. **6692.A** anthracite button  
 art. **PP6692.0** white button - collective packing 10 pcs.  
 art. **PP6692.A** anthracite button - collective packing 10 pcs.

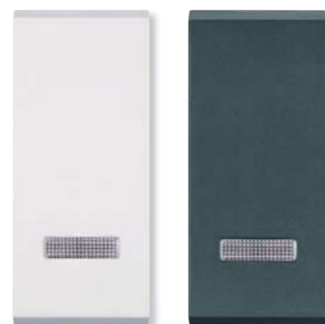

**Regulator jačine svetlosti sa naizmeničnom sklopkom 40-300VA, 230V~/50Hz**

- Za sijalice sa užarenim vlaknom i halogene sijalice sa standardnim transformatorom 230V~ 40-300W,
- Za halogene sijalice sa standardnim transformatorom 40-300VA,
- Usaglašeno sa IEC 60669-2-1,
- Ugradnja u noseću prirubnicu utiskivanjem,
- Indikacija

art. **6671.0** beli  
 art. **6671.A** antracit

**Dimmer with alternative switch 40-300VA, 230V~/50Hz**

- For the incadescent lamps and halogen lamps with standard transformer 230V~ 40-300W,
- For halogen lamps with standard transformer 40-300VA,
- Complied with IEC 60669-2-1
- Installation into the holding flange by pressing
- Indication

atr. **6671.0** white  
 art. **6671.A** anthracite



**Sklopka naizmenična sa indikacijom 16AX/250V~**

- Usaglašeno sa IEC 60669-1,
- Ugradnja u noseću prirubnicu utiskivanjem,
- Indikacija svetli kada je strujno kolo otvoreno

art. **670.0** beli taster  
 art. **670.A** antracit taster  
 art. **PP670.0** beli taster - zbirno pakovanje 10 kom  
 art. **PP670.A** antracit taster - zbirno pakovanje 10 kom

**Alternative switch with indication 16AX/250V~**

- Complied with IEC 60669-1
- Installation into the holding flange by pressing
- Indication turns on when the circuit is open

art. **670.0** white button  
 art. **670.A** anthracite button  
 art. **PP670.0** white button - collective packing 10 pcs.  
 art. **PP670.A** anthracite button - collective packing 10 pcs.



**Regulator jačine svetlosti za induktivno opterećenje 40-300VA, 230V~/50Hz**

- Za sijalice sa užarenim vlaknom i halogene sijalice 230V~ 40-500W,
- Za halogene sijalice sa standardnim transformatorom 40-300VA,
- Za halogene sijalice sa elektronskim transformatorom 40-200VA,
- Usaglašeno sa IEC 60669-2-1,
- Ugradnja na noseću prirubnicu utiskivanjem,
- Indikacija uključivosti

art. **6672.0** beli  
 art. **6672.A** antracit

**Dimmer for inductive load 40-300VA, 230V~/50Hz**

- For incadescent lamps and halogen lamps 230V~ 40-500W,
- For halogen lamps with standard transformer 40-300VA,
- For halogen lamps with electronic transformer 40-200VA,
- Complied with IEC 60669-2-1,
- Installation into the holding flange by pressing
- Indication

art. **6672.0** white  
 art. **6672.A** anthracite



**Sklopka ukrсна 2M sa indikacijom 16AX/250V~**

- Usaglašeno sa IEC 60669-1,
- Ugradnja u noseću prirubnicu utiskivanjem,
- Indikacija svetli kada je strujno kolo otvoreno

art. **671.0** beli taster  
 art. **671.A** antracit taster  
 art. **PP671.0** beli taster - zbirno pakovanje 5 kom  
 art. **PP671.A** antracit taster - zbirno pakovanje 5 kom

**Cross-switch 2M with indication 16AX/250V~**

- Complied with IEC 60669-1
- Installation into the holding flange by pressing
- Indication turns on when the circuit is open

art. **671.0** white button  
 art. **671.A** anthracite button  
 art. **PP671.0** white button - collective packing 5 pcs.  
 art. **PP671.A** anthracite button - collective packing 5 pcs.



**Regulator jačine svetlosti sa rotacionom sklopkom 800W, 230V~/50Hz**

- Za sijalice sa užarenim vlaknom i halogene sijalice 230V~ 40-800W,
- Za halogene sijalice sa standardnim transformatorom 40-400VA,
- Usaglašeno sa IEC 60669-2-1,
- Ugradnja u noseću prirubnicu utiskivanjem,
- Indikacija uključivosti

art. **6681.0** beli  
 art. **6681.A** antracit

**Dimmer with rotary switch 800W, 230V~/50Hz**

- For the incadescent lamps and halogen lamps 230V~ 40-800W,
- For halogen lamps with standard transformer 40-400VA
- Complied with IEC 60669-2-1
- Installation into the holding flange by pressing
- Indication of being on

atr. **6681.0** white  
 art. **6681.A** anthracite



**Elektronski regulator jačine svetlosti univerzalni za LED rasvetu 230V~/50Hz 200W**

- Univerzalni elektronski dimer za sve vrste sijalica
- Osnovna namena za CFL i LED sijalice do 200W
- Usaglašeno sa IEC 60669-2-1,
- Ugradnja u noseću priрубnicu utiskivanjem
- Indikacija

art. **6674.0** beli  
art. **6674.A** antracit

**Dimmer, universal for LED lighting 230V~/50Hz 200W**

- Universal electronic dimmer for all kind of lamps
- The main purpose for CFL and LED lamps up to 200W
- Complied with IEC 60669-2-1,
- Installation into the holding flange by pressing
- Indication

art. **6674.0** white  
art. **6674.A** anthracite



> **NOVO**

> **NEW**

**Infracrveni detektor pokreta 500W, 230V~/50Hz**

- Relejni izlaz max 500W za sve tipove sijalica,
- Regulacija vremena uključenosti 10 s – 10 min,
- Regulacija osvetljenosti pri kojoj senzor reaguje 2 – 2000 lx,
- Regulacija osetljivosti,
- Moгуćnost aktiviranja spoljnim tasterom,
- Vidni ugao po horizontali 110°,
- Usaglašeno sa IEC 60669-2-1,
- Ugradnja na noseću priрубnicu utiskivanjem

art. **6673.0** beli  
art. **6673.A** antracit

**Infrared motion detector 500W, 230V~/50Hz**

- Relay exit max 500W for all lamps,
- Time regulation 10 s – 10 min,
- Light treshold regulation 2 – 2000 lx,
- Sensitivity level regulation,
- External push button activation,
- Horizontal view angle 110°,
- Complied with IEC 60669-2-1,
- Installation into the holding flange by pressing

atr. **6673.0** white  
art. **6673.A** anthracite

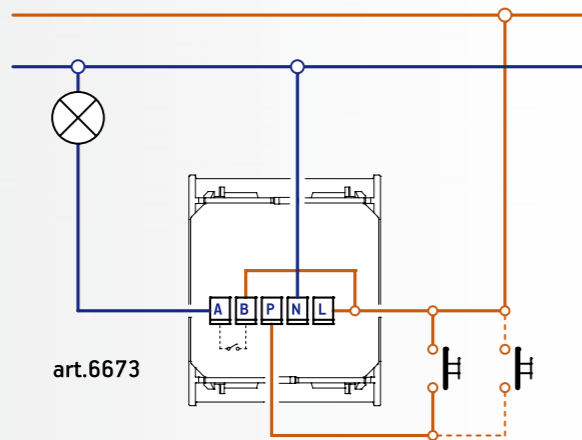

**DIMENZIJE ZA UGRADNJU (visina i dubina od ravni zida)**

**INSTALLATION DIMENSIONS (height and depth from the wall plane)**

Sklopke (širina modula 22,2 mm - ukrсна 44,4 mm)

Infracrveni detektor pokreta 500W, 230V~/50Hz (širina modula 44,4 mm)

Switches (module width 22,2mm - cross switches 44,4 mm)

Infrared motion detector 500W, 230V~/50Hz (width 44,4 mm)

Regulator jačine svetlosti 40-300VA/230V~ (širina modula 22,2 mm)

Regulator jačine svetlosti sa rotacionom sklopkom 800W/230V~ (širina modula 22,2 mm)

Dimmer 40-300VA/230V (module width 22,2mm)

Dimmer with rotary switch 800W/230V~ (module width 22,2 mm)

- Regulator jačine svetlosti sa naizmjeničnom sklopkom  
- Regulator jačine svetlosti za induktivno opterećenje 40-300VA/230V~ (širina modula 22,2 mm)

- Dimmer with alternative switch  
- Dimmer for inductive load 40-300VA/230V~ (module width 22,2 mm)

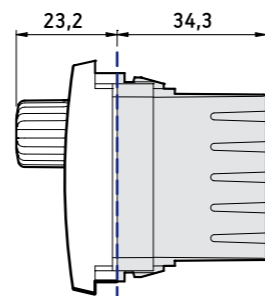
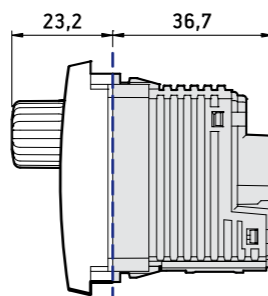
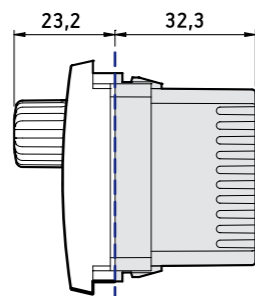
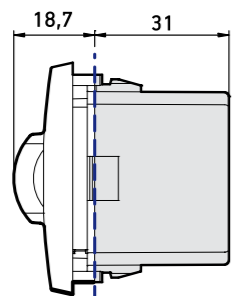
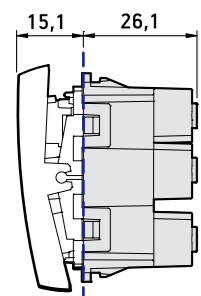

**DIMENZIJE SKLOPKI ZA KUPATILO**

**BATHROOM SWITCH DIMENSIONS**

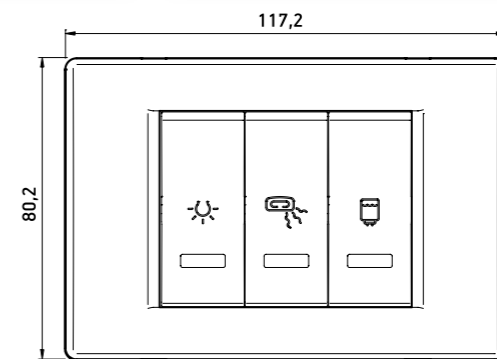
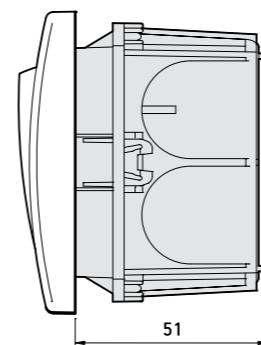

art.66911.00

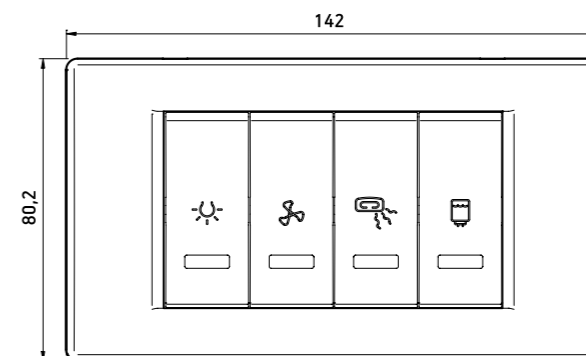

art.66913.00

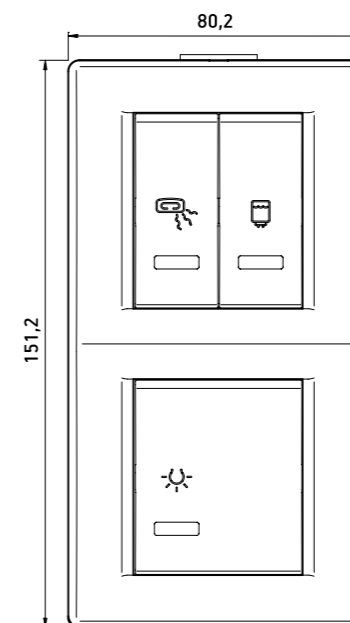
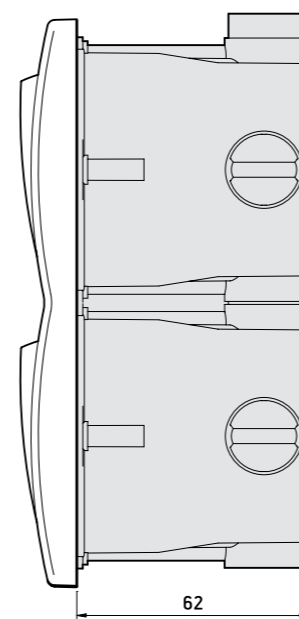

art.66912.00

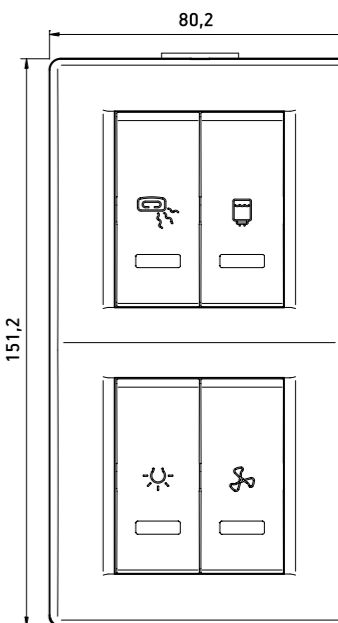

art.66914.00

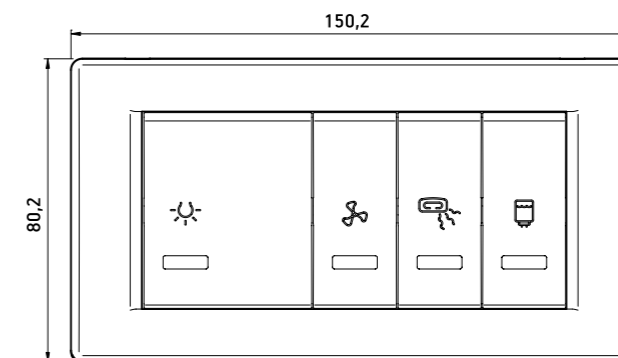
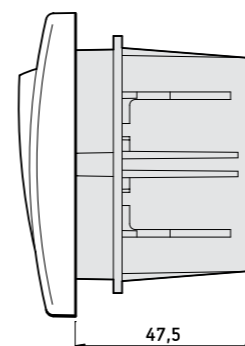

art.66915.00

▶ Sklopka za kupatilo sa indikacijom za tri nezavisna kruga 10/2x16AX 250V~ (svetlo, grejalica, bojler)

- Usaglašeno sa IEC 60669-1,
- Ugradnja u razvodnu kutiju art.6523 ili art.6533 pomoću vijaka

art. **66911.00** bela maska i beli tasteri

Bathroom switch with indication for three independent circuits 10/2x16AX 250V~ (light, heater, water heater)

- Complied with IEC 60669-1,
- Installation into the installation boxes art.6523 or art.6533 with screws

art. **66911.00** white cover and white buttons



▶ Sklopka za kupatilo sa indikacijom za tri nezavisna kruga 10/2x16AX 250V~ (svetlo, grejalica, bojler)

- Usaglašeno sa IEC 60669-1,
- Ugradnja u dve vertikalne nizajuće kutije Ø60 art.710 pomoću vijaka

art. **66912.00** bela maska i beli tasteri

Bathroom switch with indication for three independent circuits 10/2x16AX 250V~ (light, heater, water heater)

- Complied with IEC 60669-1,
- Installation into two vertical mounted installation boxes Ø60 art.710 with screws

art. **66912.00** white cover and white buttons

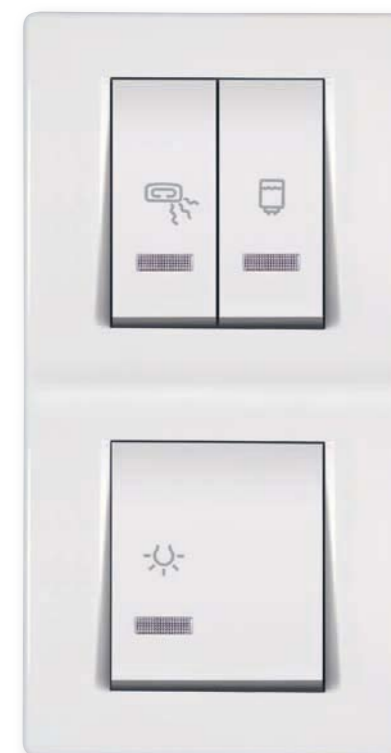

▶ Sklopka za kupatilo sa indikacijom za četiri nezavisna kruga 2x10/2x16AX 250V~ (svetlo, ventilator, grejalica, bojler)

- Usaglašeno sa IEC 60669-1,
- Ugradnja u razvodnu kutiju art.6524 ili art.6534 pomoću vijaka

art. **66913.00** bela maska i beli tasteri

Bathroom switch with indication for four independent circuits 2x10/2x16AX 250V~ (light, fan, heater, water heater)

- Complied with IEC 60669-1,
- Installation into the installation boxes art.6524 or art.6534 with screws

art. **66913.00** white cover and white buttons



▶ Sklopka za kupatilo sa indikacijom za četiri nezavisna kruga 2x10/2x16A 250V~ (svetlo, ventilator, grejalica, bojler)

- Usaglašeno sa IEC 60669-1,
- Ugradnja u dve vertikalne nizajuće kutije Ø60 art.710 pomoću vijaka

art. **66914.00** bela maska i beli tasteri

Bathroom switch with indication for four independent circuits 2x10/2x16A 250V~ (light, ventilator, heater, water heater)

- Complied with IEC 60669-1,
- Installation into two vertical mounted installation boxes Ø60 art.710 with screws

art. **66914.00** white cover and white buttons

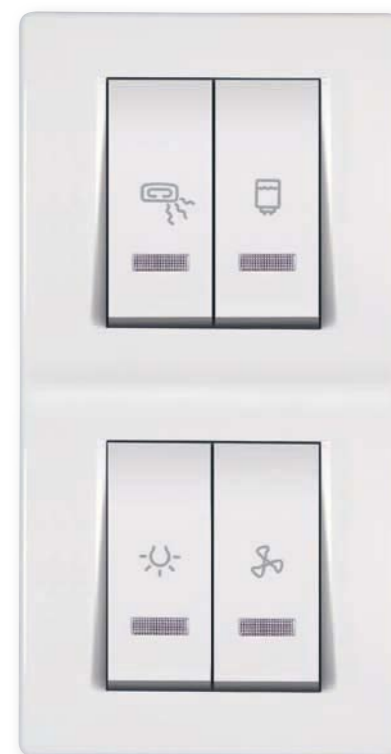

▶ Sklopka za kupatilo sa indikacijom za četiri nezavisna kruga 2x10/2x16AX 250V~ (svetlo - široki taster, ventilator, grejalica, bojler)

- Usaglašeno sa IEC 60669-1,
- Ugradnja u razvodnu kutiju art.6525 pomoću vijaka

art. **66915.00** bela maska i beli tasteri

Bathroom switch with indication for four independent circuits 2x10/2x16AX 250V~ (light - wide button, fan, heater, water heater)

- Complied with IEC 60669-1,
- Installation into the installation box art.6525 with screws

art. **66915.00** white cover and white buttons

