

D02 gG 32A/400V



Specifikacije

Šifra proizvoda	002212006
Opis	D02 gG 32A/400V
Težina	13
Nivo	Topljivi umetci (gG)
AC Prekidna moć	50
DC Prekidna moć	8
Karakteristika	gL/gG (cable protection/equipment protection)
Dimenzija	E18
Indikator	prednji
Grupa proizvoda	Niskonaponski topljivi umetci D0
Nazivni AC napon	400
Nazivna struja	32
Nazivni DC napon	250
Veličina	D02
Tip	D0

Web stranica proizvoda 

Druga dokumentacija



CE izjava
Tehnički podaci

Karakteristike granične propuštene struje

Cut-off current characteristics

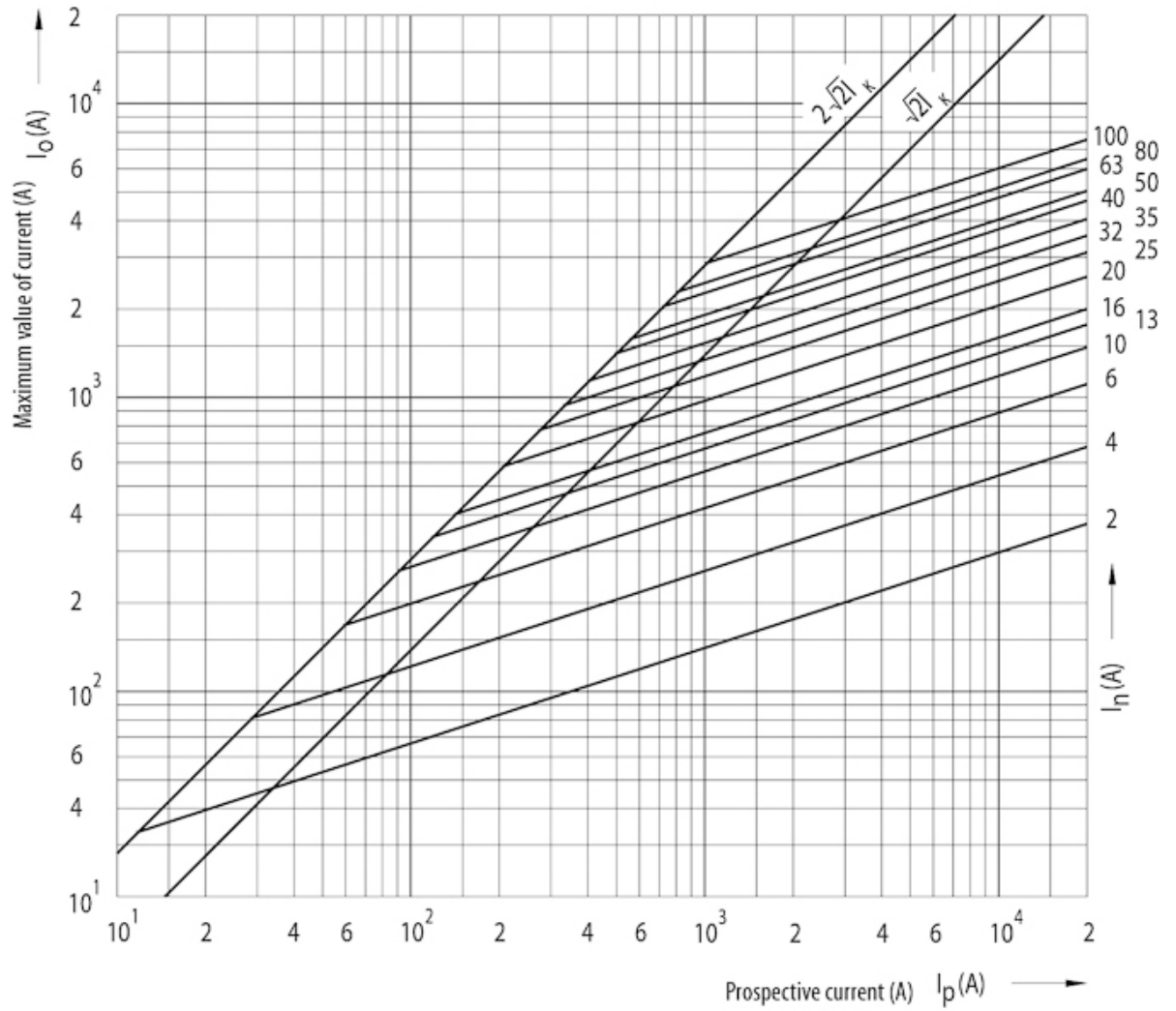

Vremensko-strujna karakteristika I/t

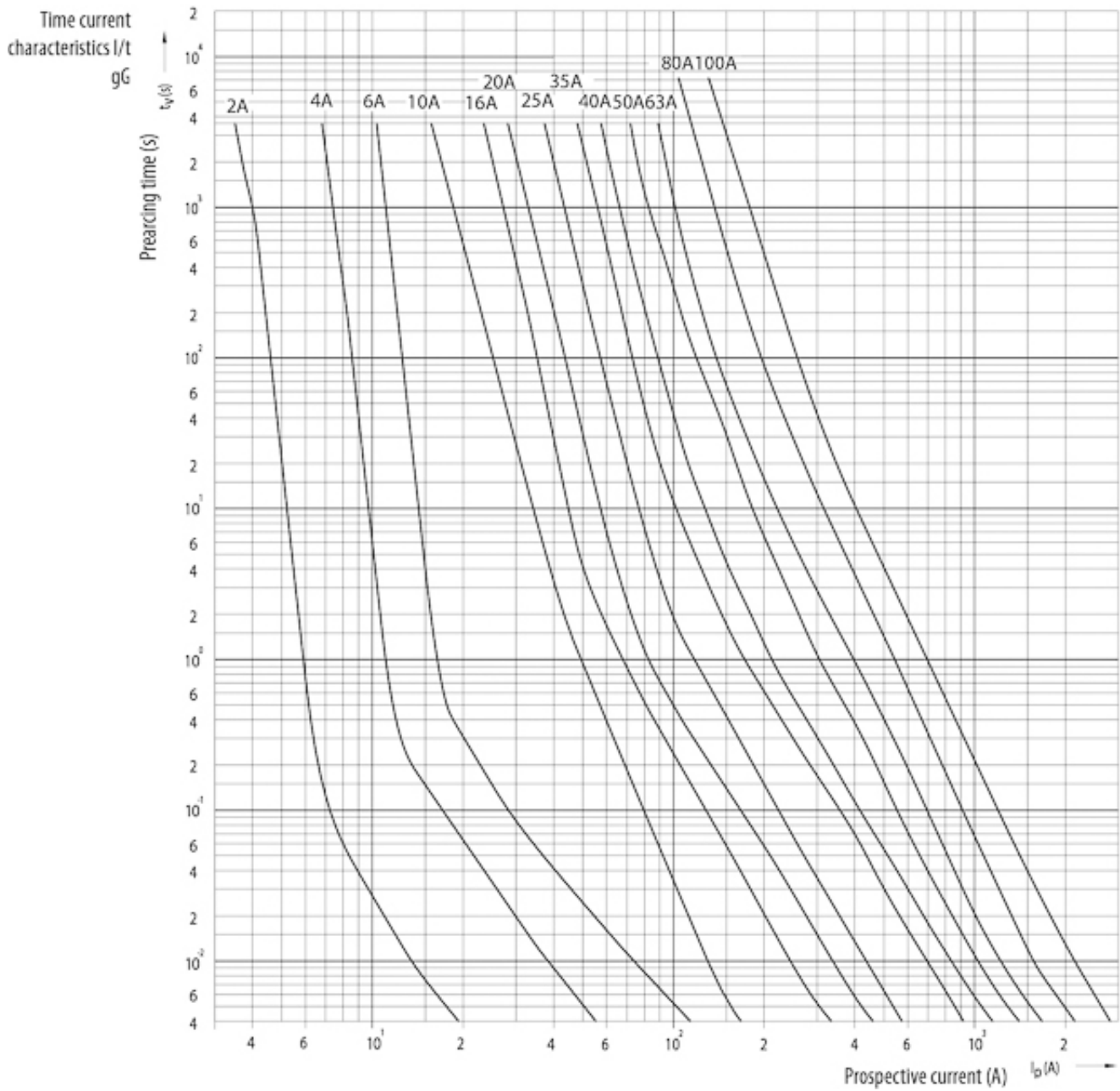

Dimenzije

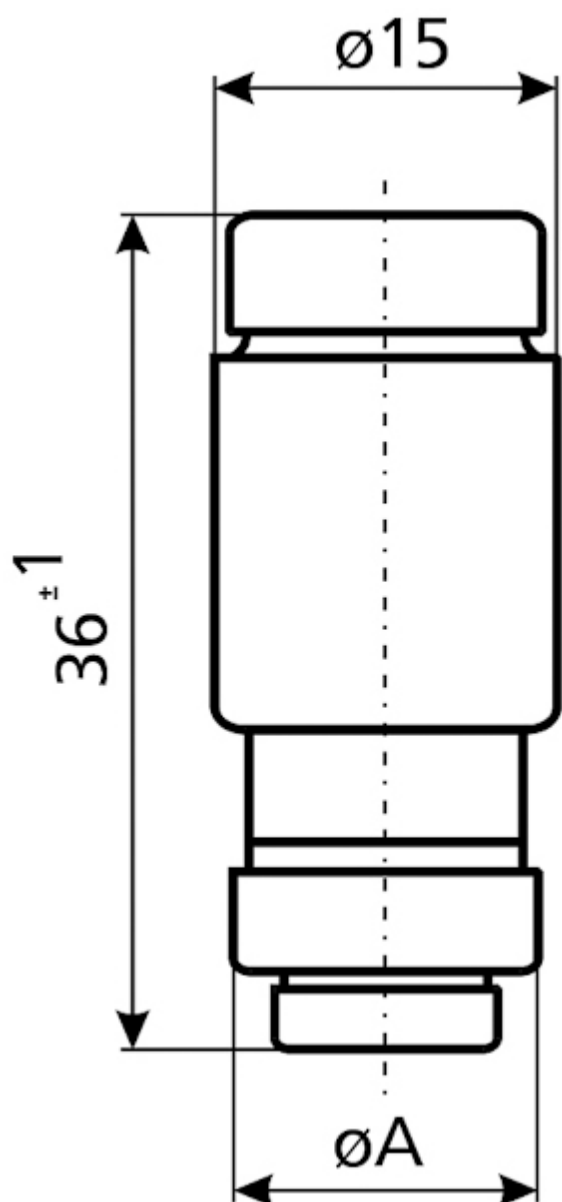

l_n [A]	$\varnothing A$
20	10,9
25	12,1
32	13,3
35	13,3
40	13,3
50	14,5
63	15,9